

Ordnance Survey (c) Crown Copyright 2018. All rights reserved. Licence number 100022432

Location Plan 1:1250

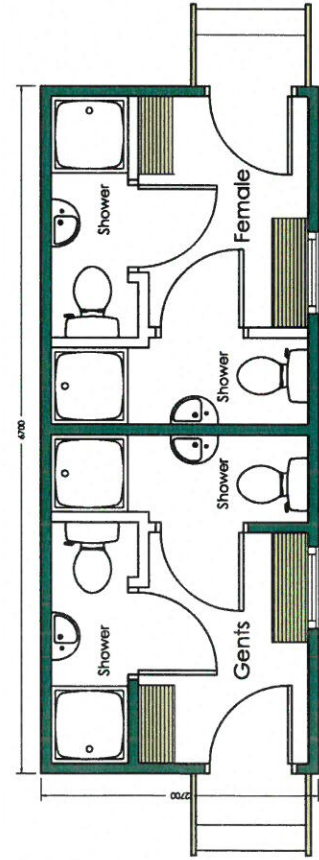

Floor Plan

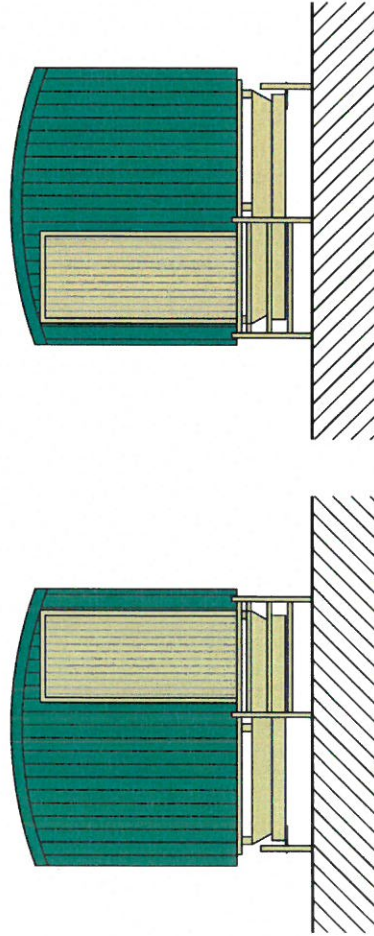
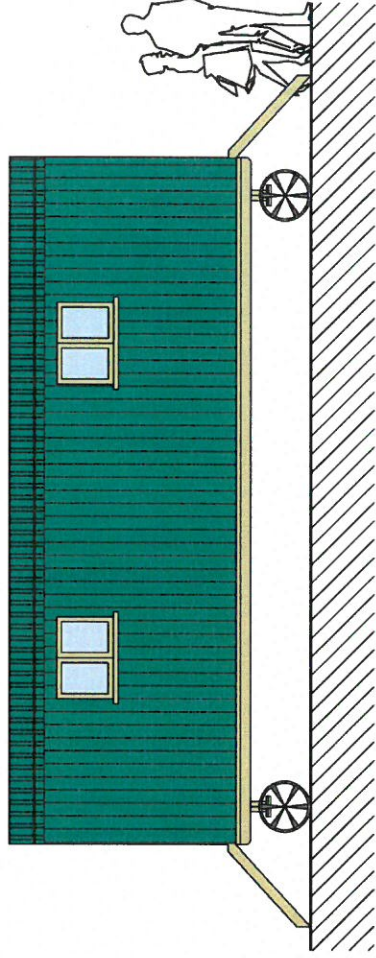

Side Elevation

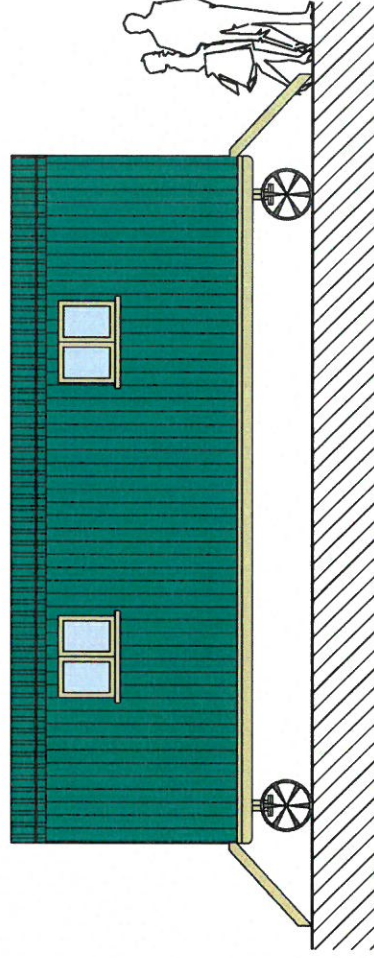

Rear Elevation



Shower Hut

Project Proposed Siting of 4 No Shepherds Huts and Shower Hut
- Planning Drawings
Address Llanfâl Hall Farm, Coedmanor, Gwynedd, LL55 1TT
Client Ms Sioned Jones
Scale 1:50 @ A3 Drawing: TY040613
TY ARCHITECTURE
10053 SHAW CLAWNS RANGE, GUYMAYR, GYMNASTRI, GYMNASTRI, GYMNASTRI, GYMNASTRI, GYMNASTRI
Tel: 01492 421667
Mobile: 07533340997
Email: ty@tyarchitect.com

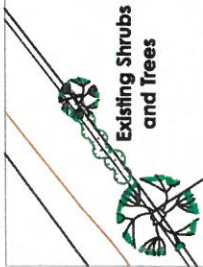

Existing Shrubs and Trees

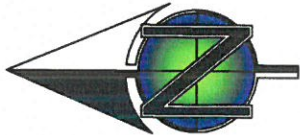

Grass Path



Hut example



Crab Apple Malus
max 8ft Height



Slate waste
to parking



Existing Access Track



Hawthorn Plants

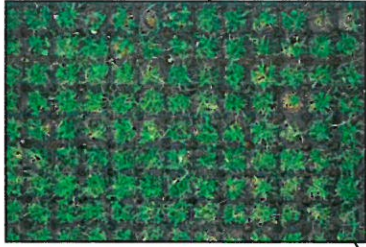

Grass Mat to Parking

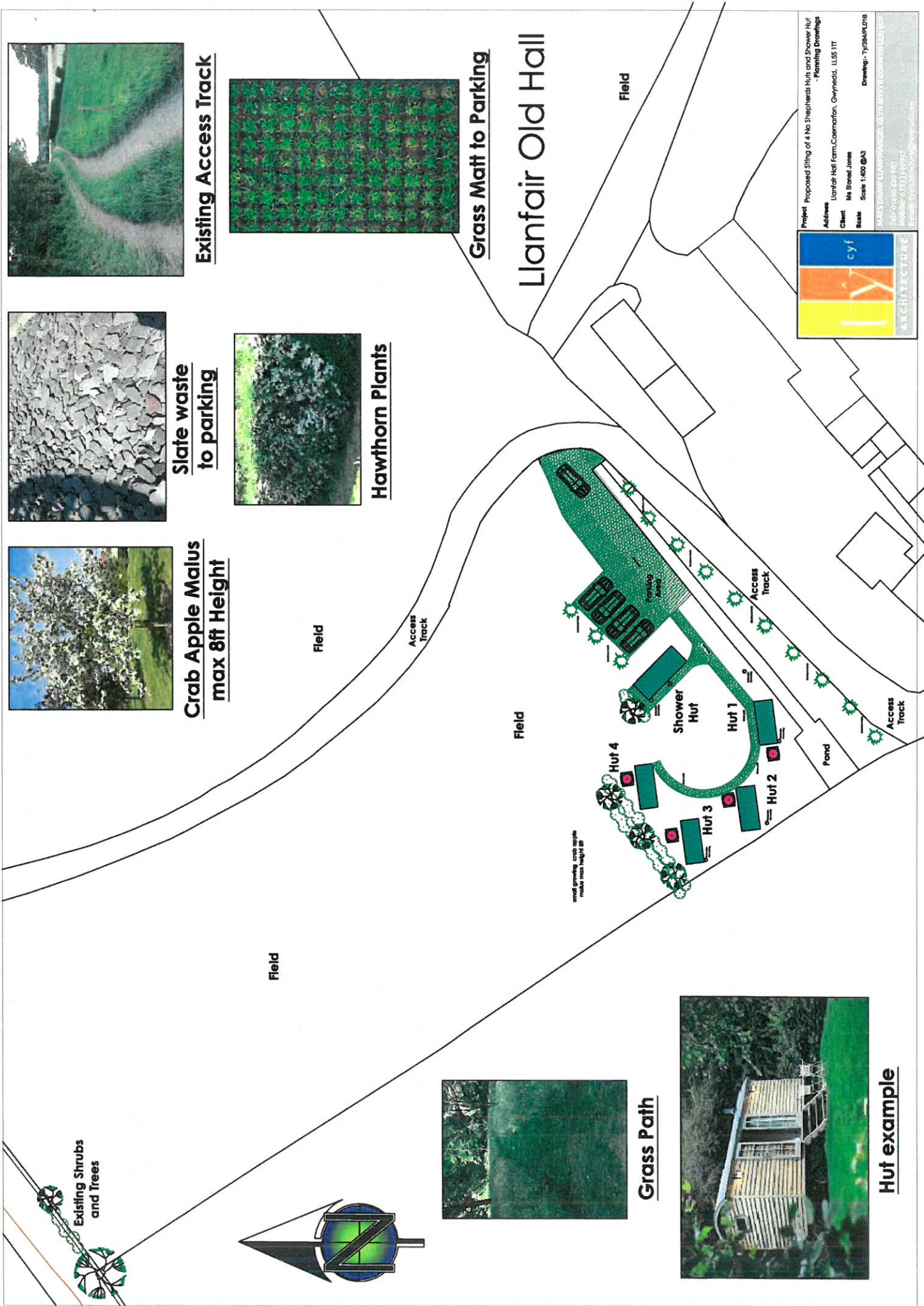

Llanfair Old Hall



Project Proposed Siting of 4 No Shepherds Huts and Shower Hut
 - Planning Drawings
 Address Llanfair Old Hall Farm, Coernomon, Gwynedd, LL55 1TT
 Client Mr Sioned Jones
 Scale 1:400 @A3
 Drawings: Tybalt/PL018
 WYNDHAM ELECTRIC
 Tel: 01492 334569
 Mobile: 01933 693937
 Email: tybalt@wyndham-electric.com

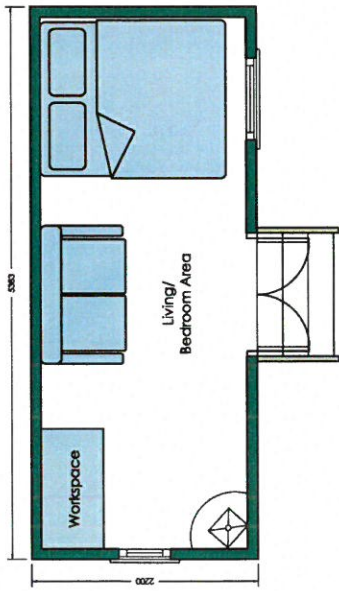

Floor Plan



Front Elevation

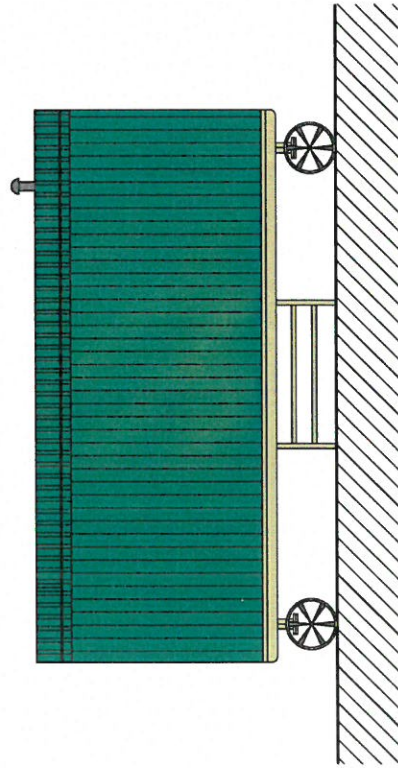

Rear Elevation

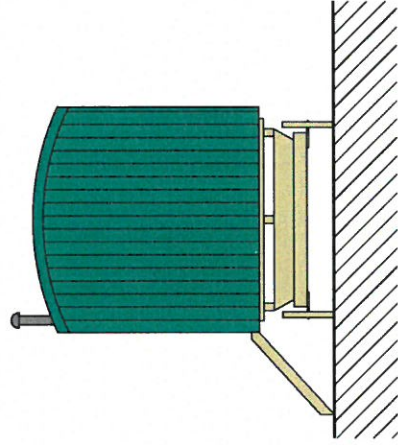

Side Elevation

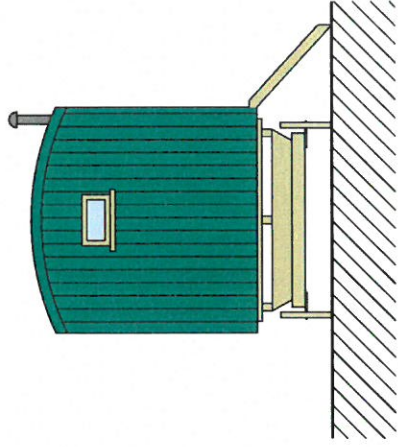

Side Elevation



Shepherds Hut

Project: Proposed Siting of 4 No. Shepherds Huts and Shower Hut
- Planning Drawings
Address: Llanfair Hill Farm, Coernoffan, Cwmreddi, LL55 1TT
Client: Mr Sioned Jones
Scale: 1:50 @ A3
Drawing: Ty046PL02
Tel: +44 (0) 1546 697
E: info@tyarchitect.co.uk
E: info@tyarchitect.com